

SLXi

— Europe's first Stage V compliant trailer unit —

SINGLE- AND MULTI-TEMPERATURE
REFRIGERATION SOLUTIONS FOR TRAILERS

Content

SLXi – THE UNIT OF CHOICE

CHOOSE, CONNECT, CARE, CONTROL. TRUST SLXi TO DELIVER INTELLIGENCE AND 24/7 CONNECTIVITY AS STANDARD	4
FUEL SAVINGS WITH PRECISE TEMPERATURE CONTROL	8
MINIMIZING YOUR TOTAL COST OF OWNERSHIP	9
QUALITY YOU CAN DEPEND ON	10
HELPING YOU CARE FOR OUR PLANET	11

SLXi, MORE THAN MEETS THE EYE

SR-3 CONTROLLER – PUTTING YOU IN CONTROL	12
WHISPER QUIET OPERATION FOR TOTAL URBAN ACCESS	14
FULLY GDP – COMPLIANT PHARMACEUTICAL TRANSPORT	15
TUNE YOUR UNIT TO YOUR NEEDS: OPTIONS & ACCESSORIES	16

SPECIFICATIONS	18
----------------	----

MULTI-TEMPERATURE CONFIGURATIONS	20
----------------------------------	----

DEALER NETWORK – EXCELLENCE WHEN AND WHERE YOU NEED IT	22
--	----

SLXi

THE UNIT OF CHOICE

The SLXi, Thermo King's new trailer refrigeration unit, sets standards of reliability, efficiency and performance that are unequalled. Control, connectivity, sustainability and choice: this unit has them all. Turn the page and see why the SLXi is the best choice for your business.



You win. Always.

Choose, connect, care, control. Trust SLXi to deliver.

The SLXi range is the result of many thousands of hours of research. But we did not confine ourselves to the laboratory. Instead we spoke to hundreds of transport companies and analysed data from over one thousand units in daily use. The knowledge acquired allowed us to evolve the proven SLX platform to meet more of your needs, to further exceed your expectations and simply to serve you better.

Fuel typically represents more than half of your Total Cost of Ownership. Imagine what a reduction of 10 to 20% could do for your bottom line.

SLXi enables you to cut fuel costs dramatically.

You told us that you need a choice of operating profiles to optimize performance and economy, depending on the load carried.

Now you can choose the ideal profile for your operation.

You asked for ease of use and elimination of operator error. Our latest SR-3 controller brings a selection of preset operating profiles which will not just be error-proof but also fully meet your operational needs.

Technology that puts you where you need to be: in control.



To effectively manage your fleet you needed full visibility of both unit and load condition, at your location and on the move. We decided to make the SLXi the first fully “telematics ready” unit by installing our first TK BlueBox communication device on every unit.

You will be able to connect anytime, anywhere.

SLXi GreenTech engines fully comply and even significantly outperform emission limits specified in the latest amendment of EU Non Road Mobile Machinery (Stage V) directive, effective from 01/2019. Your business is committed to a policy of environmental responsibility and the relentless reduction of its carbon footprint. The SLXi cuts global warming impact by 45% and CO₂ by 15%.

Your customers will know that you care for our planet.

You insisted on the very highest standards of quality, reliability and support for total peace of mind. We refined our design to reduce the stress on key components, extend unit life and cut maintenance costs.

You can trust us to deliver to the highest standards.

The SLXi is offered as an extensive range of single and multi-temperature units, customized with performance-enhancing options, to give you precisely the capabilities you need for your business.



WHISPER™ Optional for all standard models

WHISPER™ PRO Available for SLXi-300 and SLXi Spectrum models

Discover the range on europe.thermoking.com/slxi

Intelligence and 24/7 connectivity as standard

Total connectivity with the new TK BlueBox communication device including Bluetooth®

EVERY SLXi comes with TK BlueBox communication device and Bluetooth® as standard, making it the industry's first fully telematics-enabled unit. Developed by Thermo King for the transport industry, TK BlueBox has been built on a decade of proven designs and field experience. Having total connectivity means accessing the flow of critical data you need to proactively manage the complexities of a modern fleet.

EVERY SLXi is Bluetooth® enabled to communicate free of charge with your smartphone or tablet. It's easily installed on iOS or Android devices. Cellular service is available with subscription.

Having real-time information means you can view and monitor

- » Set point, return air and discharge air
- » Door status
- » Fuel status
- » Alarm status
- » Operating mode
- » Dealer locations and contact information.

EVERY SLXi has 2-way communication capability. Now you can connect and manage your unit wherever you are.

Being in control remotely means you can

- » Start or stop the unit
- » Change the temperature set point
- » Initiate defrost
- » Perform a pre-trip inspection
- » Clear alarms
- » Change the operating mode (Continuous run/Cycle Sentry).



John Collins, Driver
Delivers pharmaceuticals

"I often carry high value loads, so I need alerts if there is unapproved access or a technical hitch. And every minute counts, so it is a real bonus to manage the unit straight from my driver's seat."

My office is my cab.
Connect me and I win.

Warning: Mobile devices should never be used while driving.

NEW!

CONNECT ANYTIME, ANYWHERE.

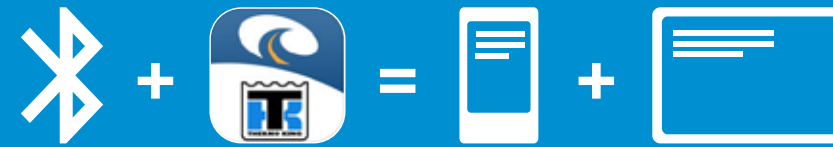

TK REEFER APP

- » Free of charge
- » Easy to install on smartphone or tablet
- » Available for iOS and Android
- » Bluetooth® enabled
- » 2-way communication capability

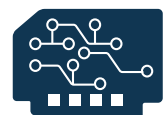
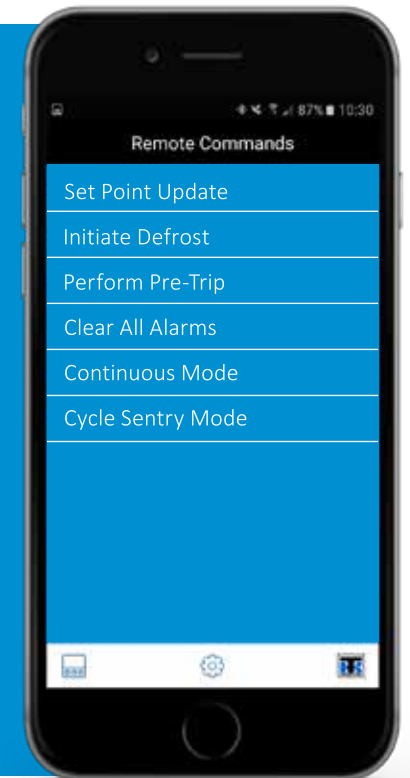

TK BlueBox communication device

Fitted as standard on every SLXi, real-time information, 2-way communication



New Tracking™ portal

Advanced online fleet and temperature management, 2-way communication capability

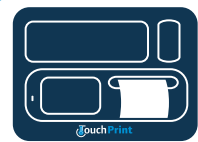

TouchPrint

Temperature data capture and print for full traceability



SR-3 controller

Remote diagnostics for total load protection, 2-way communication capability



i-BOX

Enables data exchange with third party telematics



Connectivity options

via API, expansion board*, CanBus*

Choosing what is best for your business

Fuel savings with precise temperature control

After analysing data from over one thousand trailers in real-life applications across many continents, it has become clear that many refrigeration units are not set up for optimum performance and economy. Careful study of hundreds of applications has helped us to formulate operating profiles which ideally suit real temperature controlled transport situations.

The SLXi will provide you with a choice of profiles ranging from decimal point accurate temperature control for highly sensitive loads to substantially reduced fuel consumption for less sensitive cargoes. Our Dealers have been trained to help you match operating parameters exactly to your individual requirements. This will ensure that your cargo is maintained in perfect condition and that your bottom-line benefits to the maximum possible extent.

For **economy**, a 27% larger condenser coil allows us to reduce engine speeds and cut fuel consumption while maintaining or increasing capacity and airflow.

For **Precision Temperature Control (PTC)**, we leverage the latest Electronic Throttling Valve (ETV) technology* integrated in the host unit and high frequency liquid line solenoid valve pulsing implemented in the remote evaporators. This provides rapid pull-down for temperature recovery with smooth temperature control to reduce thermal shock, minimize evaporation and increase the shelf-life of fresh produce.

Using the power and intelligence of the latest edition SR-3 controller with OptiSet™ Plus customizable operating parameters, we ensure the best setup for your particular needs and virtually eliminate the risk of operator error.

*SLXi-300, SLXi-400 and SLXi Spectrum

“In my line of business, I constantly make choices. It is good that the SLXi comes with a wide choice of operating profiles. I can save both time and money by choosing what best meets my needs, from precise temperature control to real fuel economy.”

I have
the power of choice.



Jeremy Boyle, Fleet Manager
In charge of fleet maintenance and optimisation

Minimizing your Total Cost of Ownership

A refrigeration unit, like any capital equipment, must deliver a return on investment which is quantified by calculating the Total Cost of Ownership (TCO).

- » Fuel typically comprises more than 50% of the TCO over a 7 year first life. The SLXi has been refined to deliver substantial savings of 10-20%* on average when compared with its already impressive predecessor.
- » Maintenance costs can be managed downwards and made predictable by choosing a service contract such as those offered under the ThermoKare banner.
- » Purchase price is the most visible part of TCO, but not the largest. Buying cheap is seldom buying wise. The price paid covers much more than the tangible asset of the unit itself. It also covers service support, quality, reliability, innovation, dependability and much more.
- » Operating costs can be reduced by the careful selection of the right operating profile for each load. Thermo King Dealers have considerable expertise in this area.
- » Productivity gains can be realized by using the fleet management tools made possible with TK BlueBox telematics connectivity, now standard on all SLXi units.
- » Resale value of Thermo King equipment is legendary. Expect used trailers fitted with the SLXi to sell faster than competitive units and at a better price.

*Depending on operating profiles



Quality you can depend on

Every time you move temperature sensitive cargo for your customers, you put your company's reputation on the line. To do so, you have to place total trust in the equipment you use and the support it receives. Thermo King has always viewed world-class quality, reliability and service back-up as key ingredients. With the SLXi, our passion for continuous improvement has resulted in a unit you can rely on to serve you day and night, in the harshest conditions. We can make this commitment to you on the back of a global field trial and exhaustive laboratory testing. As an SLXi owner, you will enjoy total peace of mind.

- » 27% larger condenser permits reduced engine speeds and minimizes component stress.
- » Exceptional component durability gives increased uptime and lower maintenance costs.
- » E-coated frame provides lifetime corrosion protection.
- » World leading Dealer network guarantees an expert and supportive partner, round the clock.



“Because of the high value of the goods we haul, I am looking for exceptional performance, quality and efficiency. After all, that is what our customers know they can depend on, time after time.”

If I can trust the unit and the support, I win.

Bertrand Lamet, Business Owner
Responsible for quality and efficiency

Helping you care for our planet

Every successful transport and logistics operation rates sustainability as one of its core values. The reduction of environmental impact can take many forms including:

- » the reduction of emissions (exhaust, CO₂, noise)
- » the reduction of consumption (energy, carbon fuels) and
- » the reduction of waste (land-fill, water usage, operational inefficiencies).

Thermo King has always taken a leadership position when it comes to sustainability. Ingersoll Rand made a public commitment in September 2014 to reduce operational greenhouse gas (GHG) emissions by 35% and product-related GHG by 50% by the year 2020.

- » As the market's greenest diesel trailer unit, the SLXi is loaded with features which enable you to substantially reduce the environmental footprint of your operation while actually improving profitability.
- » Micro-channel heat exchangers technology reducing refrigerant charge and minimising the risk of leakage.
- » A direct injection industrial grade engine operating at reduced RPM nominal speed provides clean, dependable power.
- » The SLXi is built in the world-renowned Thermo King Ireland plant following ISO 14000 and 18001 certified manufacturing process and achieving zero landfill.
- » All the SLXi trailer refrigeration units are fitted with GreenTech engines from Thermo King, featuring industrial grade design, direct injection as standard and reduced RPM nominal speed. These engines drastically reduce emissions, waste and noise pollution, exceeding the most stringent EU standards. GreenTech engines  are the cleanest engines on the refrigeration unit market, they are in particular fully compliant with the emission criteria specified in the latest revision of the European legislation (NRMM Stage V) effective from January 2019.

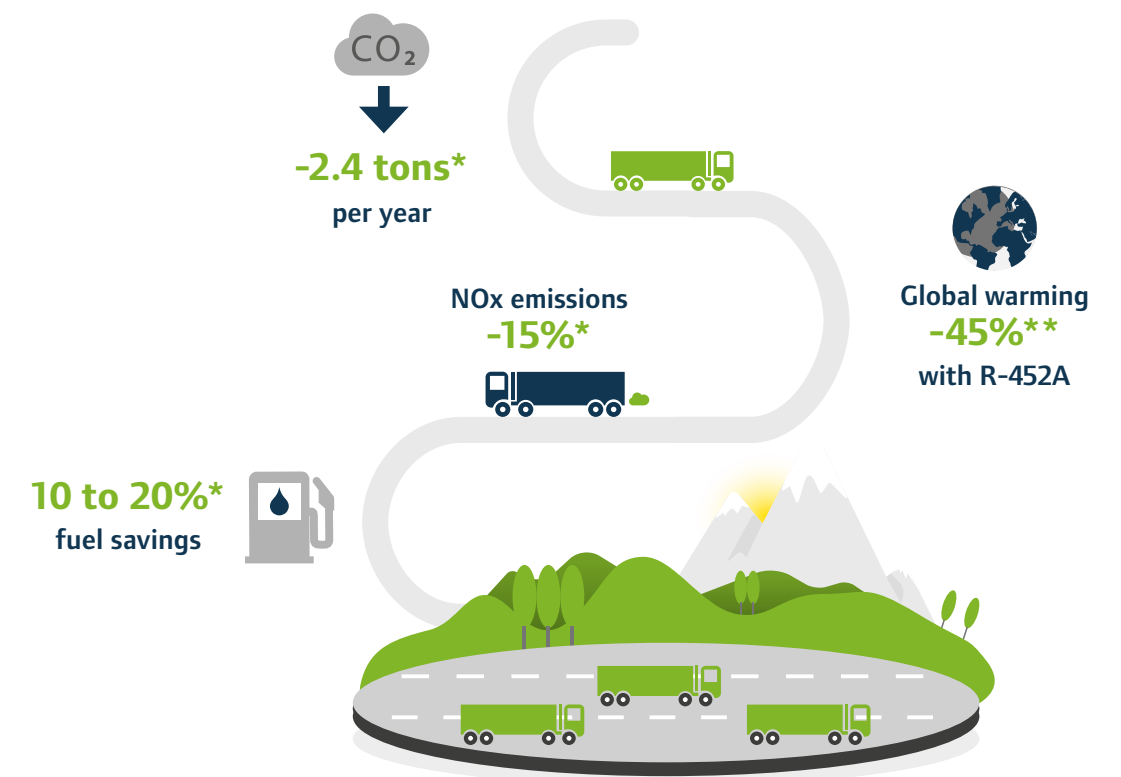

* On average, compared with predecessor
** Compared with refrigerant R-404A

SR-3 controller – putting you in control

The key to total temperature management

While the enhanced SR-3 controller boasts many new features that allow for customization, temperature control and fuel optimization, you will find that the menu system has been retained to minimize additional training. As always, an interactive tutorial is available for new drivers.

A simple, intuitive display with a choice of 23 languages has multiple functions including:

- » Changing temperature set point
- » Setting selectable alarms and menus
- » Monitoring system performance
- » Initiating a start of trip
- » Viewing all zones at the same time
- » Recording all operational parameters
- » Simultaneous zone monitoring on multi-temperature applications
- » Checking fuel level*
- » Downloading CargoWatch™ data and uploading software updates via USB port.

Load protection is ensured by a range of features including:

- » Keypad with lockout
- » Mode-lock
- » Phase correction
- » Diesel/electric auto switching
- » Set point warning
- » Wintrac™ software for data storage and analysis
- » Top freeze protection
- » Advanced system monitoring and alarm notifications
- » Precision Temperature Control (PTC) feature on multi-temperature units
- » Full suite of data recording, management and analysis tools.

CargoWatch™

A high-performance data logger for full EU compliance. Since January 2006, data logging has been a European requirement for the transport of quick frozen food (Regulation 37/2005). The SLXi comes with an on-board data logger as standard. To ensure your total compliance, CargoWatch™ is a fully approved independent logger with the following options:

- » Six temperature sensors
- » Four door switches
- » Humidity sensor
- » Data averaging
- » Programmable out-of-range alarms.



Wintrac™

Easy-to-use Windows® based reporting package for simple, rapid data downloads, data search and generation of fully customizable reports in graphic or tabular format.

OptiSet™ Plus**

Pre-set operating parameters can be loaded by a Thermo King Dealer. These are tailored to match unit performance to the precise and unique requirements of each load. This provides operating economy and load protection, while dramatically reducing the risk of operator error.

ServiceWatch™

A service logger is integrated in the SR-3 and provided as standard.

- » Enables faster and more accurate fault diagnosis
- » Reduces downtime and labour hours
- » Keeps a record of system operating modes and performance characteristics.

Greatly extended communication capabilities

The SR-3 controller is designed to support high-speed, flexible communication tasks including uploading temperature profiles or software upgrades and downloading temperature and diagnostic data. The following will be supported for data transfer and management:

- » Cable connection: when using a laptop with Wintrac™ software
- » USB key: via the USB port provided as standard, eliminating the need for laptops and cables
- » GPRS connection: via TrackKing™ tool which allows online fleet and temperature management
- » Wireless communication: As end customers demand increasing temperature traceability, transporters need a simple and effective means of accessing critical data. The SR-3 is designed to facilitate yard management and is ready to support future wireless connections.

**On single temperature models only



John Collins, Driver
Delivers pharmaceuticals

“I need to deliver for our customers, day in day out, whatever I am hauling. That means delivering on time and on temperature. No excuses. To make that happen, I need a controller that is easy to use. And if something goes wrong, I need to know what to do about it. Being in control makes it easy to do my job right, every time.”

**Easy to use.
Easy to control.**

Whisper quiet operation for total urban access

Noise is rightly considered as an environmental pollutant. For decades, Thermo King has actively prioritized noise attenuation across the product range. Purchasers of temperature control equipment need to ensure that its sound profile is fit for purpose, for example delivery operations into city centres which must meet extremely strict noise targets.

With the SLXi range, we are offering three levels of noise treatment:

- » **The standard SLXi unit**, best in class for quiet operation thanks to noise-reduced components, low engine speeds and extensive noise containment measures within the unit design.
- » An optional upgrade with **the Whisper™ noise attenuating kit**, available for most models and delivering a reduction in sound levels.
- » A top-of-the-range **PIEK certified Whisper™ Pro version**, available for the SLXi-300 and SLXi Spectrum (multi-temperature) models, which
 - » Complies with the most stringent noise abatement standards
 - » Requires no manual intervention to activate or deactivate PIEK mode
 - » Involves no additional installation or service costs being a one-piece nose-mount unit and
 - » Features a dedicated controller which monitors the time and GPS position to force the unit into PIEK mode.

Sound Pressure (dBA)

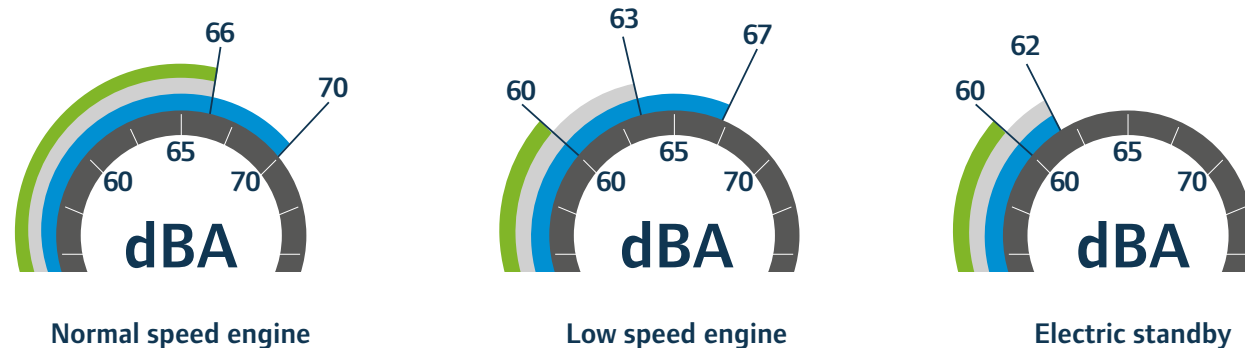

■ SLXi Standard
 ■ SLXi Whisper™
 ■ SLXi Whisper™ Pro

Fully GDP-compliant pharmaceutical transport

Most medical and biological products must be strictly temperature controlled at every stage of manufacture and distribution. Failure to do so not only risks the loss of an extremely high-value cargo but can also jeopardize public health and patient safety. Because of the special needs of this sector, Thermo King established TK PharmaSolutions, a platform of applications and services that addresses the precise needs of the industry.

Within TK PharmaSolutions, Thermo King developed a Good Distribution Practice (GDP) protocol with supervision and validation by independent specialists serving the pharmaceutical industry. This follows EU guidelines to cover design, installation, operation and performance qualification.

The SLXi now joins our range of GDP-qualified equipment for the temperature controlled transport of sensitive pharmaceutical products. Our real-time tracking and remote monitoring system TrackKing™ enables detection of temperature deviations and immediate action to secure the load. TrackKing™ is now GAMP5 validated.

Thermo King's PharmaAssist service contract helps the customer to better manage risk throughout the life of the equipment. Services include annual calibration, preventative maintenance, priority breakdown assistance and access to the iKare portal for full documentation.

For more information on TK PharmaSolutions, visit europe.thermoking.com



Tune your unit to your needs

Thermo King offers a wide range of options and accessories so you can tailor your SLXi to the specific requirements of your operation. Whether you want to better manage your fuel, control temperature or keep your battery charged, we have a tried and tested solution to meet your needs.



Fuel Management

Store

- » Fuel tank 230L plastic
- » Fuel tank 190L aluminium
- » Fuel tank 100L aluminium



Filter

- » Fuel primer
- » Fuel heater (optional)
- » Water separator



Measure

- » Fuel sensor - ultrasonic, electrical and mechanical options



Display

- » Remote monitoring through TrackKing
- » Fuel level display



Unit Management

Manage air and temperature

- » Air Chute
- » Discharge Air Control (DAC)
- » Precision Temperature Control (PTC)

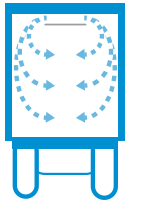

Monitor & Display

- » TouchPrint Datalogger
- » Combo display
- » Rear remote
- » Drop down HMI

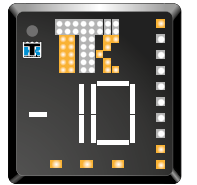

Protect

- » TK PharmaSolutions
- » Door switch
- » Remote evaporator guards
- » Unit protection guards



Battery Management

Power

- » EnergyOne Battery



Charge

- » Solar battery charger
- » Tail lift battery charger



Preserve

- » Low voltage disconnect (LVD)



For more information on Options & Accessories, visit europe.thermoking.com

Specifications

	SLXi-200	SLXi-300	SLXi-300 Whisper Pro *	SLXi-400	SLXi Spectrum	SLXi Spectrum Whisper Pro *
--	----------	----------	------------------------------	----------	------------------	--------------------------------------

REFRIGERATION CAPACITY: SYSTEM NET COOLING CAPACITY AT 30°C AMBIENT TEMP. UNDER A.T.P. CONDITIONS													
Return air temperature to evaporator	°C	0°C	-20°C	0°C	-20°C	0°C	-20°C	0°C	-20°C	0°C	-20°C	0°C	-20°C
Capacity on engine power	W	13500	7500	15000	7900	16500	9400	18700	10000	19100	9000	18400	9000
Capacity on electric standby	W	10500	5900	11900	6200	10100	5800	13200	7100	11200	6100	10500	6100
Capacity on engine power / PIEK Mode	W	-	-	-	-	10800	6500	-	-	-	-	12400	5800

HEATING CAPACITY: BOX TEMPERATURE + 2°C							
Capacity on engine power (Outside air temperature: -20°C)	W	8000	12000	12000	13300	12000	12000

AIRFLOW: ON HIGH-SPEED ENGINE OPERATION							
Airflow volume @ 0 Pa static pressure	m³/hr	5000	5000	5000	5500	5000	5000
Airflow volume in fully loaded trailer	m³/hr	4680	4680	4680	5100	4680	4680
Box length	m	15	15	15	16	15	15
Discharge velocity (air throw)	m/sec	14	14	14	16	15	15

WEIGHT: INCLUDES BATTERY							
Model 30: cooling and heating on engine operation	kg	737	737	822	737	759	844
Model 50: cooling and heating on engine & electric standby operation	kg	793	793	878	792	814	900

ENGINE: LOW EMISSION, 4 CYLINDER, LIQUID COOLED							
Model		TK486V	TK486V	TK486V	TK486V	TK486V	TK486V
Rating	kW	17.9	17.9	17.9	17.9	17.9	17.9
Maintenance interval	hrs	3000	3000	3000	3000	3000	3000

COMPRESSOR: LIGHTWEIGHT ALUMINIUM ALLOY, 4 CYLINDER, WITH BY-PASS OIL FILTER							
Model		X430 C5	X430 C5	X430 C5	X430 C5	X430 C5	X430 C5
Displacement	cc	492	492	492	492	492	492

ELECTRIC STANDBY MOTOR							
Voltage / phase / cycles	V/Ph/Hz	400/3/50	400/3/50	400/3/50	400/3/50	400/3/50	400/3/50
Rating	kW	9.3	9.3	9.3	9.3	9.3	9.3

REFRIGERANT: R-452A ZERO OZONE DEPLETION POTENTIAL (ODP), INTERNATIONALLY APPROVED							
Charge	kg	5	5	5	5.5	9.5 **	9.5 **

PULL DOWN							
+20°C to -20°C	(min)	160	150	130	120	/	/

	S-2	S-3	S-2 + S-2	S-2 + S-3	S-3 + S-3	S-4.2
--	-----	-----	-----------	-----------	-----------	-------

RETURN AIR TO EVAPORATOR		0°C	-20°C	0°C	-20°C	0°C	-20°C	0°C	-20°C	0°C	-20°C	0°C	-20°C
Capacity (up to)	W	6700	4000	8500	5000	10700	6050	12400	7100	13300	7100	9900	5500

AIRFLOW							
Airflow volume @ 0 Pa static pressure	m³/hr	1400	2050	2700	2800	3900	2320
Discharge velocity (air throw)	m/sec	9.5	9.5	9.5	9.5	9.5	9.5

WEIGHT							
	kg	36	51	87	102	102	65

*PIEK Certified version with fully automated geofenced High Speed/Low Speed Lockout
 **Refrigerant charge can vary depending on the multi-temperature zone plans
 Specifications are subject to change without notice.

DIMENSIONS (MM)

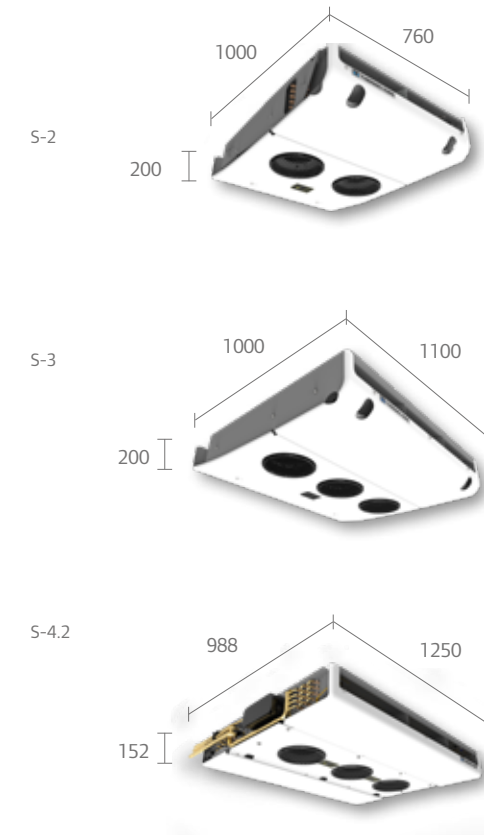

WARRANTY CONDITIONS

Thermo King warrants the new product delivered will be free of defects in material and workmanship for the period of time specified in the applicable warranties. Specific terms of the Thermo King warranty are available on request.

Multi-temperature zones

2 zones

TEMPERATURE		ZONE 1		ZONE 2			
		HOST UNIT		REMOTE EVAPORATOR			
		Airflow	Refrigeration capacity ⁽¹⁾	Model	Airflow	Maximum dimensions ⁽²⁾	Refrigeration capacity ⁽¹⁾
(°C)		(m ³ /h)	(W)		(m ³ /h)	(meter)	(W)
A	0/30°C	5000	15050	S2	1400	a = 3.5	6700
	-20/30°C		8550				4000
B	0/30°C	5000	15050	S3	2050	a = 5.3	8500
	-20/30°C		8550				5000
C1	0/30°C	5000	15050	S2+S2	2700	a = 7.1	10 700
	-20/30°C		8550				6050
C2	0/30°C	5000	15050	S4.2	2320	a = 6.0	9900 ⁽³⁾
	-20/30°C		8550				5500 ⁽³⁾
D	0/30°C	5000	15400	S2+S3	2800	a = 7.2	12400
	-20/30°C		8200				7100
E	0/30°C	5000	15050	S3+S3	3900	a = 9.5	13300
	-20/30°C		8550				7100
G	0/30°C	5000	15050	S2	1400	a = 0.8	6700
	-20/30°C		8550				4000
H	0/30°C	5000	15050	S2+S2	2700	a = 0.8	10 700
	-20/30°C		8550				6050
I	0/30°C	5000	1050	S3	2050	a = 1.25	8500
	-20/30°C		8550				5000
J	0/30°C	5000	15050	S3+S3	4000	a = 1.25	13300
	-20/30°C		8550				7100

⁽¹⁾ Individual capacity of each zone.

⁽²⁾ Maximum recommended dimensions: these are guidelines based on airflow and air velocity requirements. For each application, a heat load calculation must be performed. All calculations are based upon the following assumptions: Trailer wall k value = 0.4W/m²K, internal trailer length up to 13.5 m, height up to 2.6 m, width up to 2.5 m, zero heat load from produce carried. For information on configurations not shown here, contact your Thermo King Area Sales/Service Manager.

⁽³⁾ Preliminary data. ATP certification in progress.

Zone plans

2-zone adjustable

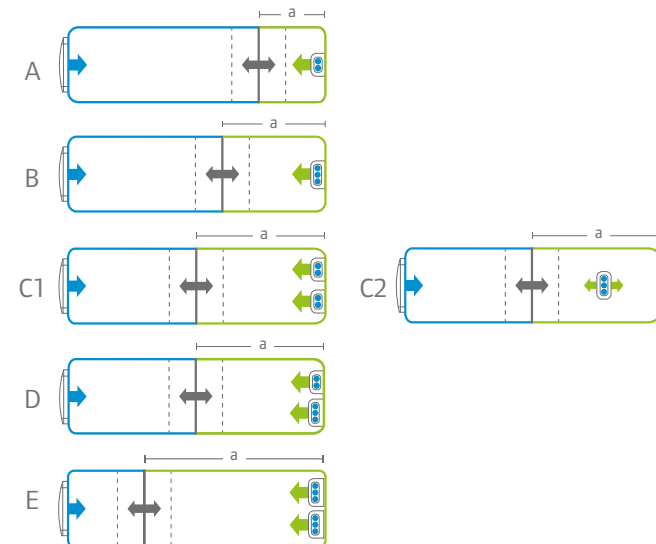

2-zone lane

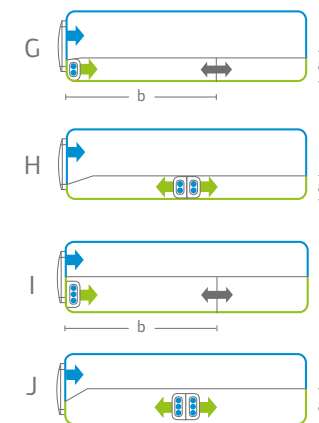

3 zones

TEMPERATURE		ZONE 1		ZONE 2			ZONE 3				
		HOST UNIT		REMOTE EVAPORATOR			REMOTE EVAPORATOR				
		Airflow	Refrigeration Capacity ⁽¹⁾	Model	Airflow	Maximum Dimensions ⁽²⁾	Refrigeration Capacity ⁽¹⁾	Model	Airflow	Maximum Dimensions ⁽²⁾	Refrigeration Capacity ⁽¹⁾
(°C)		(m ³ /h)	(W)		(m ³ /h)	(meter)	(W)		(m ³ /h)	(meter)	(W)
M	0/30°C	5000	15050	S2	1400	a = 3.5	6700	S2	1400	b = 3.5	6700
	-20/30°C		8550				4000				
N	0/30°C	5000	15050	S3	2050	a = 5.3	8500	S3	2050	b = 5.3	8500
	-20/30°C		8550				5000				
O	0/30°C	5000	15050	S3	2050	a = 5.3	8500	S2	1400	b = 3.5	6700
	-20/30°C		8550				5000				
P1	0/30°C	5000	15050	S2+S2	2700	a = 7.1	10 700	S3	2050	b = 5.3	8500
	-20/30°C		8550				6050				
P2	0/30°C	5000	15050	S4.2	2320	a = 6.0	9900 ⁽³⁾	S3	2050	b = 5.3	8500
	-20/30°C		8550				5500 ⁽³⁾				
P3	0/30°C	5000	2050	S4.2	2320	a = 6.0	9900 ⁽³⁾	S4.2	2320	b = 6.0	9900 ⁽³⁾
	-20/30°C		4450				5500 ⁽³⁾				
Q	0/30°C	5000	15050	S3+S3	3900	a = 9.5	13 300	S3	2050	b = 5.3	8500
	-20/30°C		8550				7100				
R	0/30°C	5000	15050	S2	1400	a = 9.5	6700	S2	1400	b = 9.5	6700
	-20/30°C		8550				4000				
U	0/30°C	5000	15050	S2	1400	a = 9.5	6700	S3	2050	b = 8.0	8500
	-20/30°C		8550				4000				

⁽¹⁾ Individual capacity of each zone.

⁽²⁾ Maximum recommended dimensions: these are guidelines based on airflow and air velocity requirements. For each application, a heat load calculation must be performed. All calculations are based upon the following assumptions: Trailer wall k value = 0.4W/m²K, internal trailer length up to 13.5 m, height up to 2.6 m, width up to 2.5 m, zero heat load from produce carried. For information on configurations not shown here, contact your Thermo King Area Sales/Service Manager.

⁽³⁾ Preliminary data. ATP certification in progress.

Zone plans

3-zone adjustable

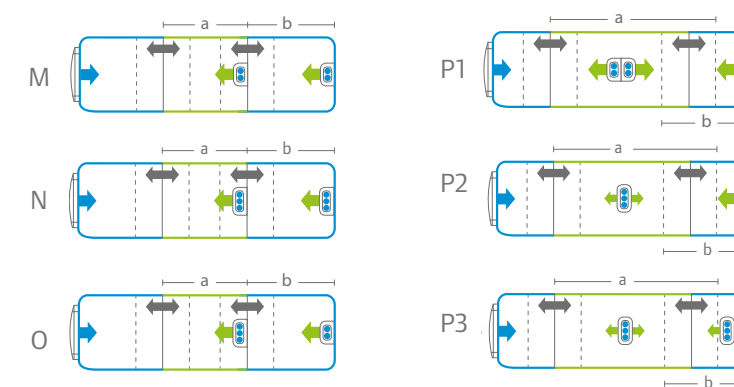

3-zone lane

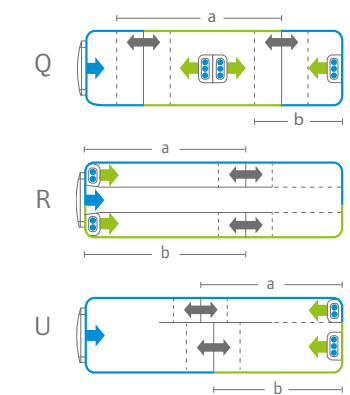



OUR DEALER SERVICE NETWORK ANYTIME, ANYWHERE, ALWAYS THERE

THERMO KING'S DEALER NETWORK IS THE MOST EXTENSIVE IN THE BUSINESS

- » Over 500 authorized service points in 75 countries
- » 1400 fully trained and certified technicians with Gold, Silver and Bronze Certi-Tech expertise certifications
- » Open and available 24/7



FIND THE DEALER CLOSEST TO YOU WITH OUR ONLINE DEALER LOCATOR
DEALERS.THERMOKING.COM

MORE DEALER SERVICES

- ✓ Emergency assistance
- ✓ Service contracts
- ✓ Genuine Thermo King parts
- ✓ Options and Accessories
- ✓ Mobile service
- ✓ Calibration and leak testing
- ✓ ...

As a Thermo King owner, you have invested in trusted and proven technology. So when maintaining your unit, it makes sense to choose original Thermo King replacement parts. It is reassuring to know that every part has been exhaustively tested to the same world-class standards as your Thermo King unit. Genuine parts last longer and perform dependably day after day, year after year.

Talk to your dealer to find the best solution for your needs and know you always get the best.

ALWAYS INSIST ON GENUINE THERMO KING SERVICE PARTS.



ThermoKare is a complete selection of service contract solutions designed to optimise fleet efficiency, minimize operating costs and maximize equipment resale values. When you choose a ThermoKare programme you let the experts service your fleet while you focus on your business. Your Thermo King Dealer will take care of maintenance planning, scheduling, invoice interpretation and general fleet administration.



ThermoAssistance is a multilingual telephone service putting you in contact with an authorised Thermo King Service Dealer whenever the need arises. It is available across Europe 24/7/365.

TELEMATICS: INTELLIGENT SERVICES AND SMART DATA MANAGEMENT



The transportation industry has always been about connectivity. It brings products to consumers all over the world and has enabled a global marketplace. Today, connectivity has taken on even greater meaning due to the amazing technologies that are within our grasp. Thermo King's Telematics portfolio offers innovative data storage, transfer and management solutions giving you the competitive edge in food safety, regulatory conformity, fleet usage and data control.

TK BlueBox, TrackKing, Wintrac are just a few examples. Check it out on europe.thermoking.com/telematics



THERMO KING

Thermo King – by Trane Technologies (NYSE: TT), a global climate innovator – is a worldwide leader in sustainable transport temperature control solutions. Thermo King has been providing transport temperature control solutions for a variety of applications, including trailers, truck bodies, buses, air, shipboard containers and railway cars since 1938.

For further information, please contact:
europe.thermoking.com

Find your nearest dealer on
dealers.thermoking.com

TRANE
TECHNOLOGIES